

Read the instruction before operating your shade

**Installation & Maintenance Instructions
Honeycomb Shades
45 & 62mm Woven Cordless / Cordless TDBU**

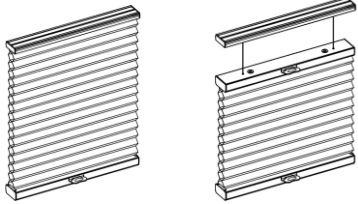

Getting Started



Remove shade from package. Save packaging until shade is installed and working to your satisfaction.

Tools:

- Level
- Measuring Tape
- Pencil
- Power drill (6mm hex driver and drill bit)
- Screwdriver



You will need to use the following fasteners for your particular mounting surface.

Surface	Fastener
Wood	Screws (Provide) 
Drywall/Plaster	Wall Anchors, Expansion Bolts (Not Provide) 
Metal	Sheet Metal Screws (Not Provide) 

Check Component/Hardware:

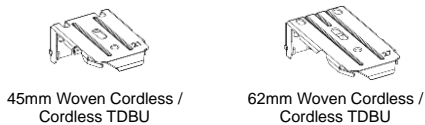

Installation Bracket

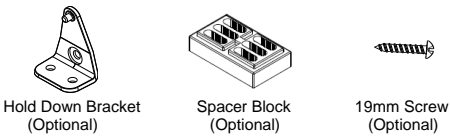

Step 1: Bracket Installation

The installation for Woven cordless, Woven cordless TDBU are the same. Below take Woven Cordless as an example for installation.

- Measure 127mm from both ends of the head rail. Mark the bracket location on the mounting surface. Proper alignment of brackets will make installation easier.

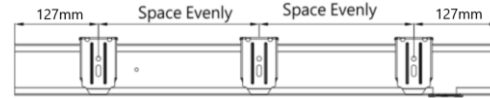

Inside Mount

For 45mm Woven Cordless & Cordless TDBU:
Allocate a minimum distance (L1) from wall to the front of brackets

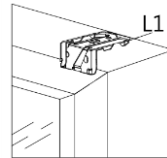

Distance	Application Condition
L1 ≥ 7mm	•With light guard front and back
L1 ≥ 3mm	•Without light guard, & with light guard at back

For 62mm Woven Cordless & Cordless TDBU:

Allocate a minimum distance of (L1) from wall to the front of brackets.

- Use two 38mm screws to secure brackets. Use wall anchors for drywall or plaster wall.

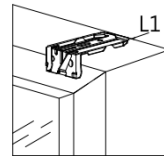

Distance	Application Condition
L1 ≥ 6mm	•With light guard front and back
L2 ≥ 3mm	•Without light guard, & with light guard at back

Outside Mount

For 45mm Woven Cordless & Cordless TDBU:
Allocate a minimum distance of 5mm from the end of brackets with the top window frame.

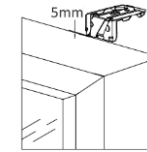

For 62mm Woven Cordless & Cordless TDBU:

Allocate a minimum distance of 5mm from the end of brackets with the top window frame.

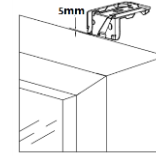

Note: If spacer block is required for outside mount, please follow the following guide:

Please always make sure the raised side of the spacer block is against the bracket.

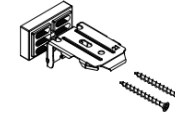

If 2pcs spacer blocks are required, please follow the illustration to attach the spacer blocks.

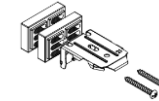

Mount the combination of the bracket and 1 set spacer block with two 38mm screws, for 2 sets spacer blocks with two 50mm screws.

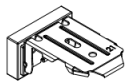
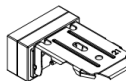
The window frame protrudes from wall by 0~10mm, one spacer block is used.	
The window frame protrudes from wall 10~18mm, two spacer blocks are used.	

Step 2: Shade Installation

- Position head rail at an angle so that it is hooked to the front of the bracket. Then push it upward to snap into the bracket.

For proper installation, start with attaching the front rail to the bracket.

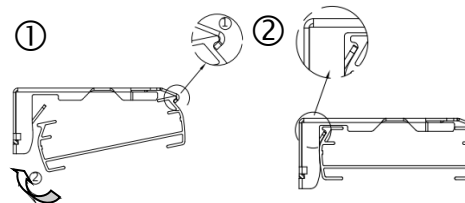

For easier installation, move the middle rail of cordless TDBU a little bit off before installing the headrail.

Step 3: Handle Installation

- Step 1: Position the handle at an angle as shown below so that it is hooked to the rail.
- Step 2: Then push it to snap into place, there will be a "Click" sound.
- Step 3: Check if handle's upper and lower hooks firmly hook to the rail.

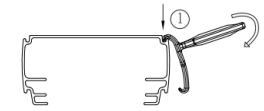

Step 1

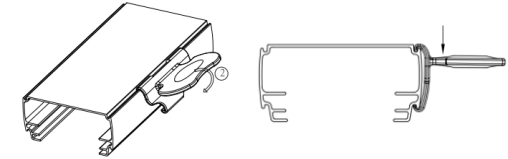

Step 2

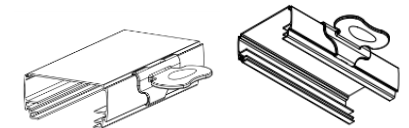

Step 3

Step 4: Install Light Guard (Optional for IM)

Please install the light guard after installation of the shade is completed.

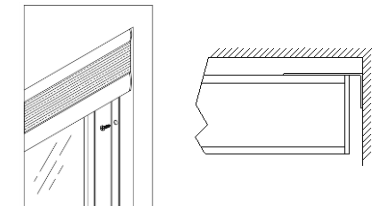

With light guard at back

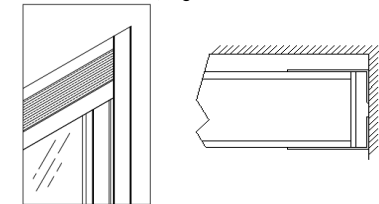

With light guard at front and back

a. The light guard is to be placed at back or front of the shade at left & right side.

Place the light guard vertically towards the bottom window frame. To avoid scraping, leave a 2mm gap between fabric stack and light guard. And then mark out the location with a pencil.

Remove the double sided tapes on the narrow side of the light guard and carefully paste the light guard to the window frame in position.



b. For better fixing the light guard to the window, use 18.5mm flat head screw to secure the light guard through the pre-drilled hole.

c. When light guard length (L)>2438mm, light guard will be sliced into 2 pieces. There are two conditions as listed below.

Light guard length(L)	Short piece Light Guard Length	Long piece Light Guard Length
2438mm $L \leq 3048\text{mm}$	610mm	L-610mm
L > 3048mm	L-2438mm	2438mm

When light guard sliced into 2pcs, firstly paste the longer piece of light guard vertically towards the bottom window frame, and paste the shorter piece of light guard above the longer one, the edges must be carefully aligned.

To avoid the edges from scraping the fabric, use the protective sticker to completely cover the joint of the two pieces of light guard on both front and back sides of light guard as diagram on the right.

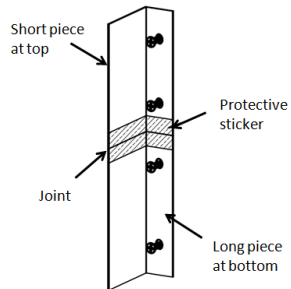

Step 5: Shade Operation

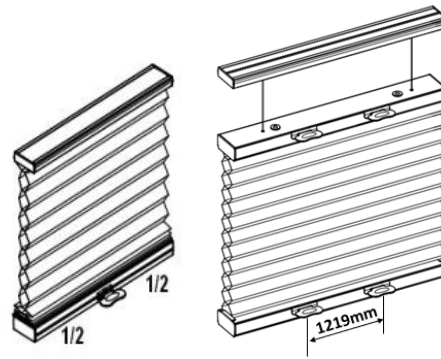

When two handles are required, the distance between the 2 handles should be 1219mm as shown above

To lower the shade, gently pull down the shade on the bottom rail handle and stop at the desired location. For TDBU, pull down the bottom rail first before lowering the middle rail.

To raise the shade, gently raise the shade on the bottom rail handle to desired height. For TDBU, if the shade will not lift, pull the middle rail down fully to the bottom first and then raise the bottom rail together with middle rail up.

⚠ Do not grasp the rail unevenly. Always lower or raise the shade in the middle or use both hands with even pressure to operate both handles on the rail.

Step 6: How to Install Hold Down (If applicable)

A. For Hold Down Bracket

• Use 19mm screw to secure each bracket.

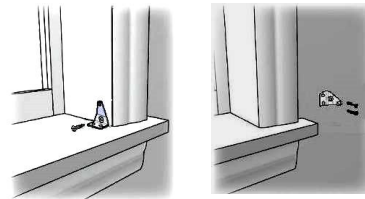

B. For Magnetic Hold Down

Use M3x15mm screw to secure the magnet catch at the below location. Make sure the magnet catch align with the pre-installed magnet on shade bottom rail.

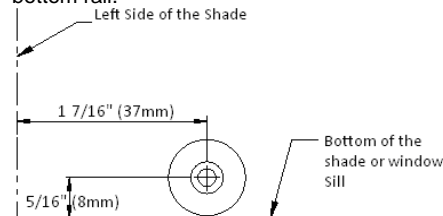

Remove the Shade

Woven Cordless & Cordless TDBU

- For Woven Cordless, fully raise the shade.
- For TDBU, lower the mid rail
- Then gently pry the bracket off the head rail with a flat screwdriver as below picture.
- Remove the shade.

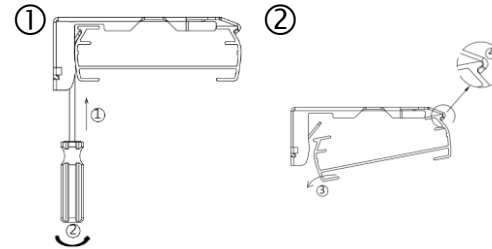

Cleaning the Shade

Routine cleaning will help maintain the beauty of your shade. The shade can be cleaned by using a soft brush, vacuumed with a low suction hand-held vacuum, cleaned ultrasonically (specify that a mild solution must be used and that the head rail should never be immersed in liquid).

Spot cleaning is not recommended, but if necessary, dampen a clean cloth with a warm water and mild detergent solution to dab the spot until it's gone (do not rub!).

Troubleshooting

Problem	Solution
The shade will not snap into the mounting brackets	Check if mounting brackets are aligned. Refer to Step 1.
The shade will not lift- Woven cordless	Gently pull down on the bottom rail to reactivate the cordless mechanism. Repeat if necessary.
The shade will not lift- Woven cordless TDBU	Pull the midrail down fully to the bottom first and then raise the bottom rail together with midrail up.
The shade stack up unevenly	Lower the shade completely, then raise it up to correct it. Repeat if necessary.
For Woven fabrics, repeated rubbing of where it comes with the window edge may cause the fabric edges to fray slightly over time	To remedy, use a pair of fabric scissors to gently trim the fraying.